

Beautifully  
Traditional

ARCADE™

TECHNICAL DETAILS

For full technical details on all our products,  
please visit our website [www.arcadebathrooms.com](http://www.arcadebathrooms.com)

Arcade single lever bidet mixer  
with pop up waste

ARC13, ARC13 CHR

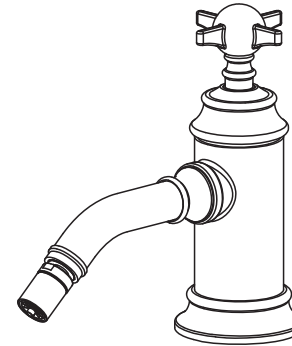

INSTALLATION INSTRUCTIONS

## INSTALLATION INSTRUCTIONS

Please read these instructions carefully and keep in a safe place for further reference.

### General Installation Requirement

The installation must comply with regulations of the Local Water Authority as contained in their bylaws. It will be necessary to fit non-return valves on both the hot and cold feeds. It is very important that all pipework is flushed thoroughly after installation to avoid impurities damaging the ceramic discs.

### Minimum/Maximum working pressure

These taps are suitable for high and low pressure installations. They are fitted with quarter turn ceramic disc headwork which provides a smooth movement. The minimum work pressure is 0.2 bar. The maximum work pressure is 5 bar. If the mains pressure is over 5 bar, a pressure reducing valve should be fitted.

### Approvals

All taps are manufactured using materials tested and approved under the Water Bylaws Scheme and comply with requirements of European standard EN200 where applicable.

### Preparations and bylaw requirements

Water Bylaws require that where hot water is supplied from tank and cold from mains, non return valves are fitted on both hot and cold pipes as close as possible to the tap. These are not supplied. Where combination boilers are fitted, it is only necessary to shut off the incoming mains and turn the boiler off. Non return valves are not required.

### Warning

Before installing the new taps, it is essential that you thoroughly flush through the supply pipes in order to remove any remaining swarf, solder or other impurities. Failure to carry out this simple procedure could cause problems or damage to the working of the taps.

These hints are prepared for your guidance; you must exercise due care at all times. We do not accept responsibility for any problems that may occur through incorrect installation.

## DIMENSIONS

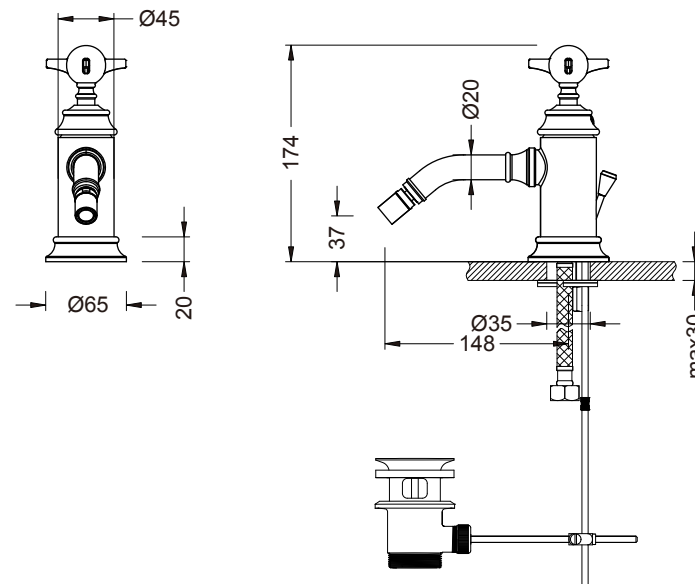

NOTE: ALL DIMENSIONS IN MILLIMETRES

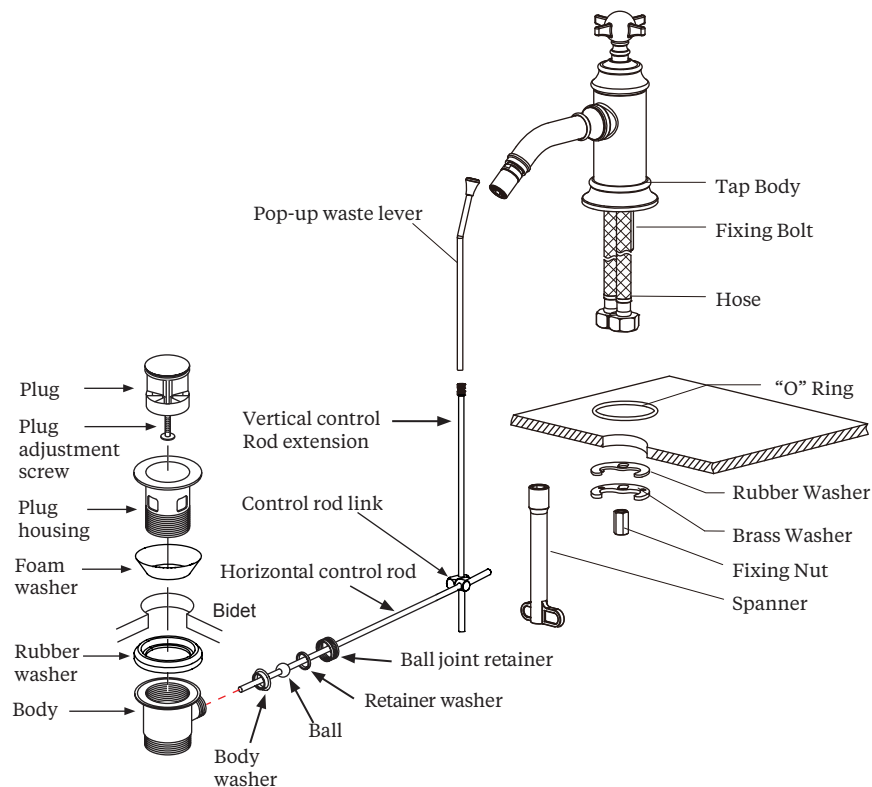

**ATTENTION**

Having first checked all new connections, turn on the mains stop cock, close all taps except the new taps and as the system starts to refill, check for leaks. Once you have satisfied yourself that there are no leaks, switch on the water heating.

**INSTALLATION INSTRUCTIONS**

First shut off your water heating system, then with your mains stop cock closed, open the lowest cold and hot taps in the house and allow to run until the cold storage tank and pipes are empty (the hot storage cylinder always remains full).

Fitting isolating valve to inlet feeds is recommended for ease of maintenance.

**INSTALLATION**

Note: Remember to turn off mains water supply before connecting to any existing pipe work.

**1: Install the main body:**

- a) Fit the "O" ring into the groove on the underside of the tap body.
- b) Screw the fixing bolt and the flexible hoses into the mixer body, and fully hand tighten.
- c) Pass the tail of flexible pipes through the hole on the bidet from above, and place the mixer in position on the bidet, to see if any alteration to the existing supply pipe work is necessary. Make any necessary alterations to the pipe work if needed.
- d) Tighten the rubber washer, the brass washer with the fixing nut from the under-side of the bidet. Check that the mixer body is correctly positioned, fully tighten the fixing nut.
- e) Connect the water supply pipes to the tails of the flexible hoses for the hot water and cold water.

**2: Pop-up waste**

- a) Insert the pop-up waste lever into the slot at the back of the mixer body.
- b) From the underside of the bidet screw the pop-up waste lever into the control rod extension.
- c) Assemble the pop-up waste to the bidet, with the foam washer on top and the rubber washer below and hand tighten.
- d) Push the body washer into the body of the pop-up waste, prepare the horizontal control rod by sliding on the retainer washer and ball joint retainer making sure the cup part of the retainer washer will sit around the ball. Slide the control rod link onto the vertical control rod and then onto the horizontal control rod.
- e) Insert the short end (with ball) of the horizontal control rod into the body (the horizontal control rod can be slid through the control rod link) and clamp to the body with the ball joint retainer. Do not over tighten.
- f) Test the action of the pop-up waste and fully tighten the control rod link. Adjust the ball joint retainer if required.

## MAINTENANCE

**Note :** Remember to turn off the water supply before commencing any maintenance.

### Cleaning the headwork

The concealed headwork should give trouble free service, but in the event of any problem, service is straight forward.

### To remove the headwork

Unscrew the top of the tap and then use a suitable adjustable spanner (not supplied) to loosen the nut. Take the headwork out and wash it with clean running water. Make sure any trapped debris has been removed. Dry and lightly grease the seal (only use silicone grease). Refit the headwork followed by the handle body and lever.

## CLEANING

The nickel/chrome plate we use on our taps is very durable, nevertheless care should be taken when cleaning. It should be cleaned only with warm soapy water followed by rinsing with clean water and drying with a soft cloth. All finishes are vulnerable to acid attack and some strong substances such as household cleaners, disinfectants, denture cleaners, hair dyes, wine making and photographic chemicals can cause the surface to go black or peel.

### Adjusting the spout

If necessary, please follow below steps to adjust the spout.

1. Loosen the grub screw under the spout.
2. Slightly turn the spout to the desired position.
3. Tighten the grub screw.

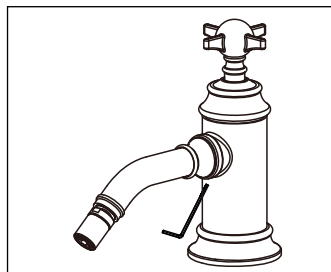

## FILTER CLEANING

Taps are supplied with two different filters : low pressure Flow Straighteners ( factory fitted ) and high pressure Neoperl Aerators ( in the box ). These fit into the front of the tap nozzle.

**Before use :** unscrew the filter and allow the water to run freely for 5 minutes. Screw the filter back into the nozzle once all impurities have been flushed from the water supply.

**Periodically :** Using the key provided in the box unscrew the filter from the nozzle and rinse with clean running water. Once all loose debris and dirt has been cleared replace the filter into the nozzle and tighten with the key provided.

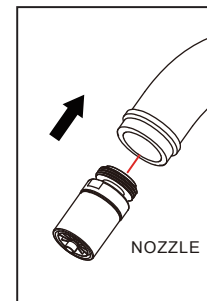
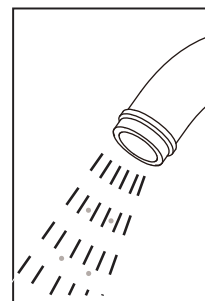
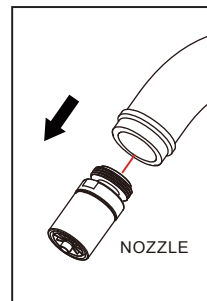

## FILTER NOZZLES

### Flow Straightener Filter and Neoperl Aerator Filter

The taps are supplied with factory fitted Flow Straightener filters for low pressure water systems. If the water pressure is high ( above 1 bar ), replace the flow straightener filter with the high pressure Neoperl aerator filter.

Use the Neoperl key supplied in the box to unscrew the Flow Straightener from the nozzle. Replace with the Aerator filter. If you misplace the supplied Neoperl key, use the top of the spare filter to unscrew the filter from the nozzle.



FLOW STRAIGHTENER

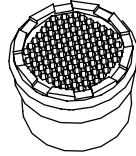

AERATOR

### THE QUALIFICATIONS

This product should only be fitted by a qualified plumber to the equivalent of UK NVQ (National Vocational Qualification) or SNVQ (Scottish National Vocational Qualification) Level 3. Should the installation be completed by a non-qualified person then the guarantee may be considered invalid.